

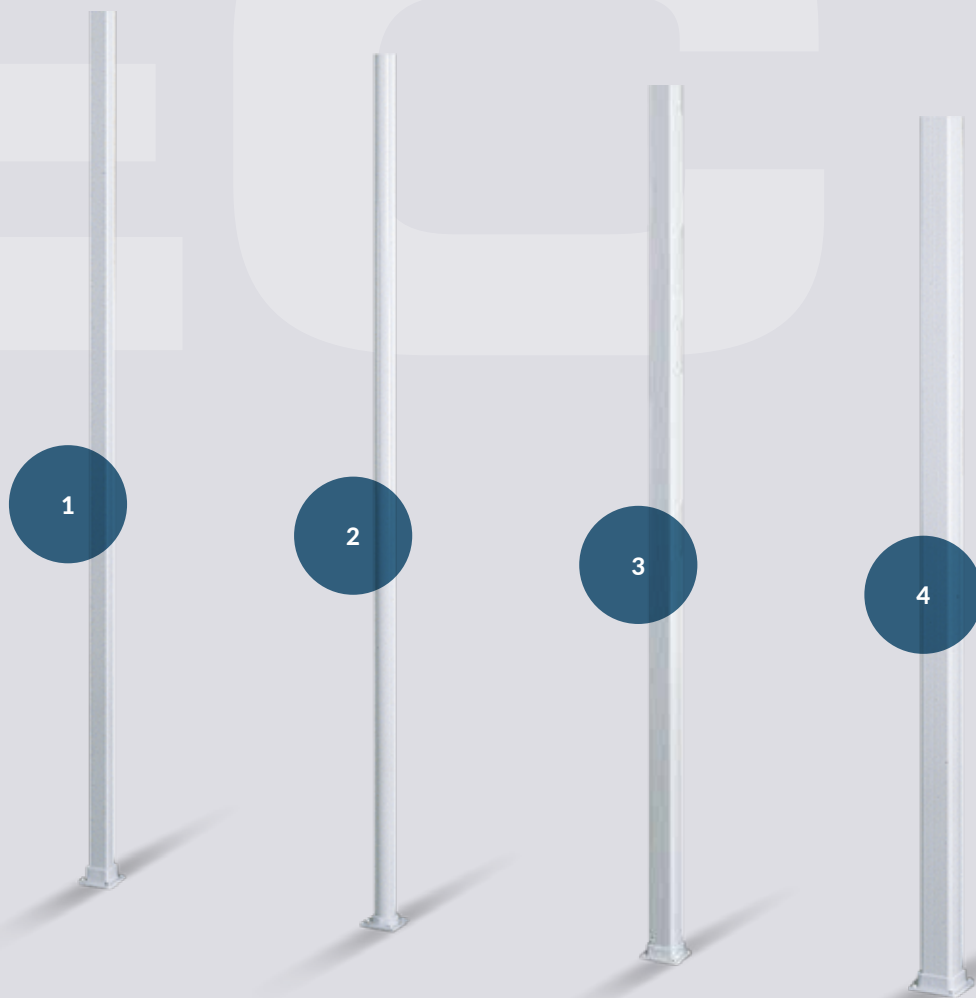

## POTEAUX STANDARD POSTS



### CARACTÉRISTIQUES





Hauteurs disponibles : 8', 9', 10', 11', 12' et plus. Une base est incluse avec chaque poteau. Un chapiteau est en option.

### FEATURES

Heights available: 8', 9', 10', 11', 12' and higher. A base is included with each post. A capital is optional.

- 1. S-200
- 2. S-R3
- 3. S-330
- 4. S-350

### POTEAU ET COLONNE POST AND COLUMN

-  Blanc | White
-  Noyer | Hickory
-  Brun commercial | Commercial Brown
-  Gris charbon\* | Charcoal Grey\*
-  Noir | Black

\*Gris charbon n'est pas disponible pour tous les modèles. | \*Charcoal Grey is not available for all models.  
Consultez les échantillons pour les couleurs exactes et les disponibilités. | Consult our samples for exact colors and availability.



POTEAUX STANDARD  
POSTS

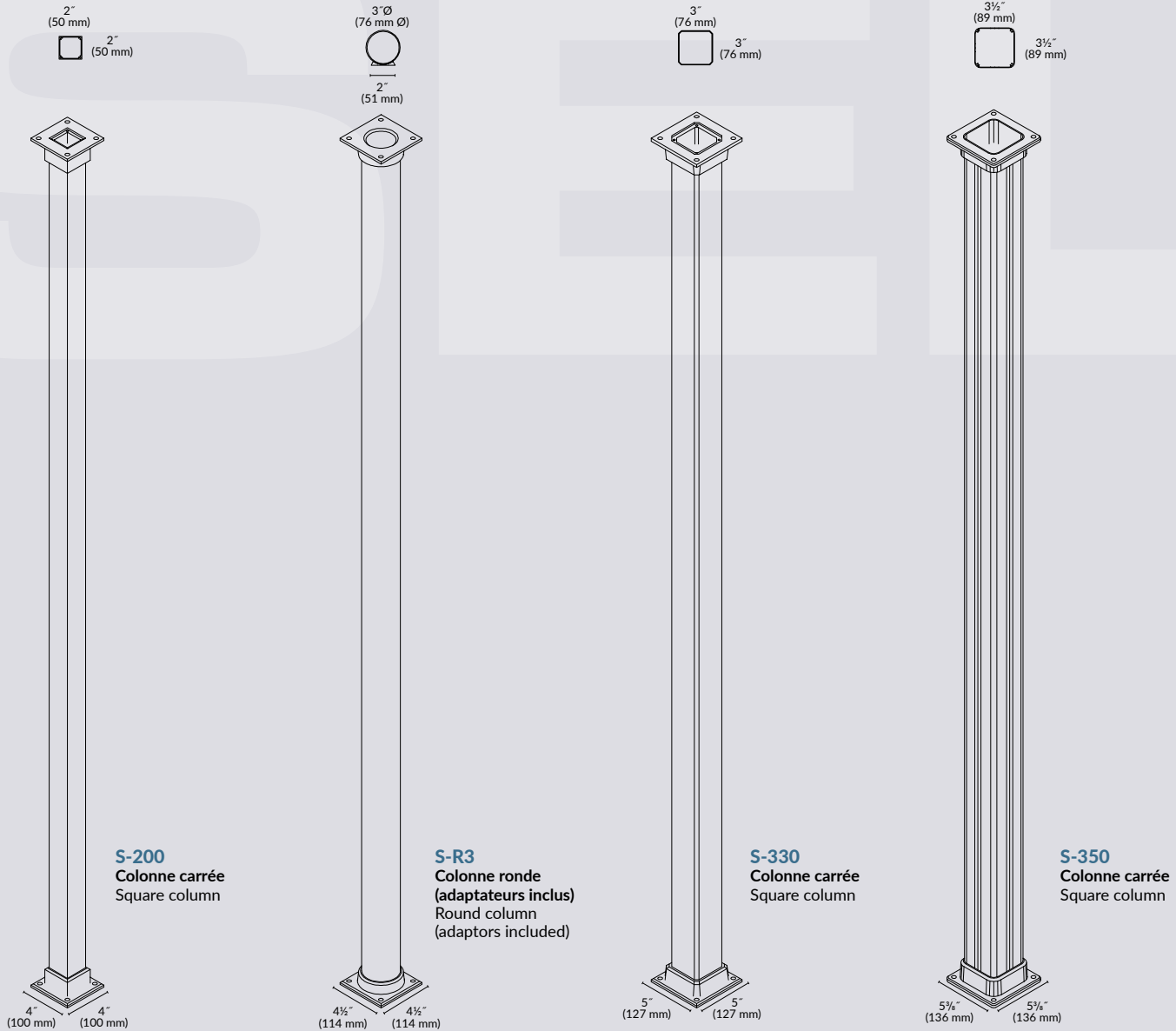

CHARGES MAXIMALES PERMISES DES / MAXIMUM LOADS PERMITTED  
COLONNES / POTEAUX D'ALUMINIUM / ALUMINUM COLUMNS / POSTS

TYPE	DIMENSIONS	CHARGES MAXIMALES PERMISES (LIVRES) MAXIMUM LOAD PERMITTED (LBS)			
		8'-0 MAX	9'-0 MAX	10'-0 MAX	12'-0 MAX
S200	2.00X2.00X0.063	1900	1500	1250	N.A.
S-R3	3" DIAMETRE	2680	2565	2410	N.A.
S330	3.00X3.00X0.061	3600	2300	1900	N.A.
S350	3.50X3.50X0.055	5770	5000	4000	N.A.

POTEAU ET COLONNE  
POST AND COLUMN

- Blanc | White
- Noyer | Hickory
- Brun commercial | Commercial Brown
- Gris charbon\* | Charcoal Grey\*
- Noir | Black

Ces produits sont fabriqués de profilés d'aluminium avec peinture cuite. | These products are made of extruded aluminium with a baked paint finish.

\*Gris charbon n'est pas disponible pour tous les modèles. | \*Charcoal Grey is not available for all models.

Consultez les échantillons pour les couleurs exactes et les disponibilités. | Consult our samples for exact colors and availability.





COLONNES DE FACE ET DE COIN  
SINGLE COLUMN AND CORNER COLUMN

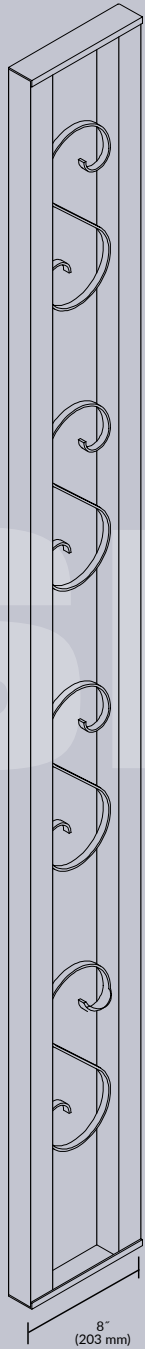

**CS-210**  
2" x 2"  
Colonne de face  
Single Column

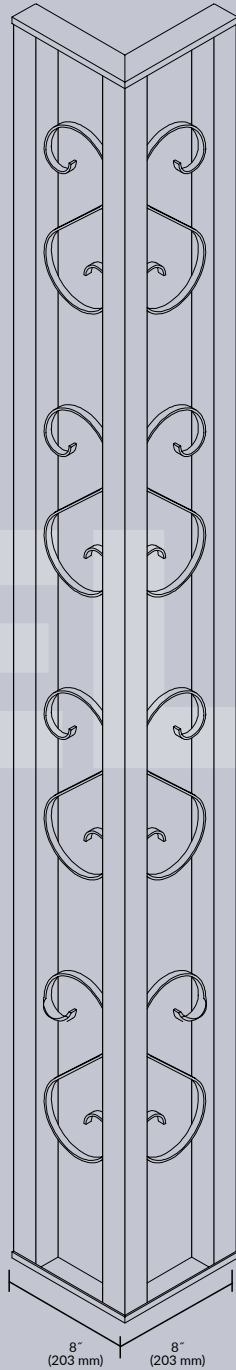

**CD-215**  
2" x 2"  
Colonne de coin  
Corner Column

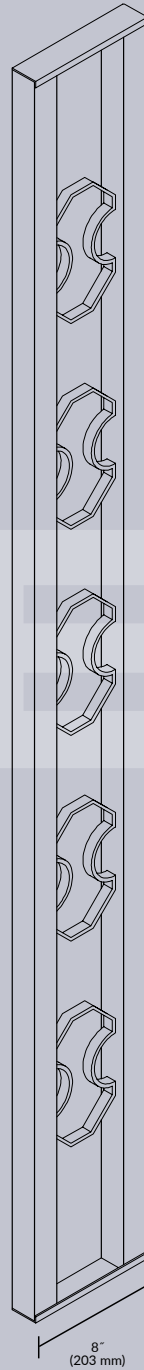

**CS2U**  
2" x 2"  
Colonne de face  
Single Column

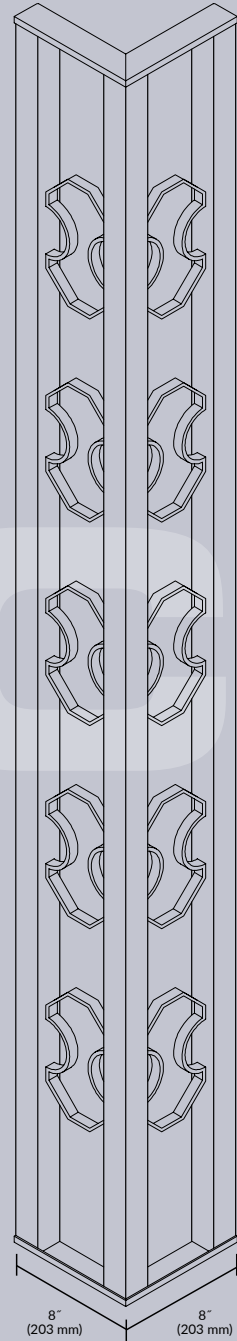

**CD2U**  
2" x 2"  
Colonne de coin  
Corner Column

POTEAU ET COLONNE  
POST AND COLUMN

- Blanc | White
- Noyer | Hickory
- Brun commercial | Commercial Brown
- Gris charbon\* | Charcoal Grey\*
- Noir | Black

Ces produits sont fabriqués de profilés d'aluminium avec peinture cuite. | These products are made of extruded aluminium with a baked paint finish.  
Consultez les échantillons pour les couleurs exactes et les disponibilités. | Consult our samples for exact colors and availability.

**SELECT**<sup>MC</sup>





COLONNES SELECT  
SELECT COLUMNS

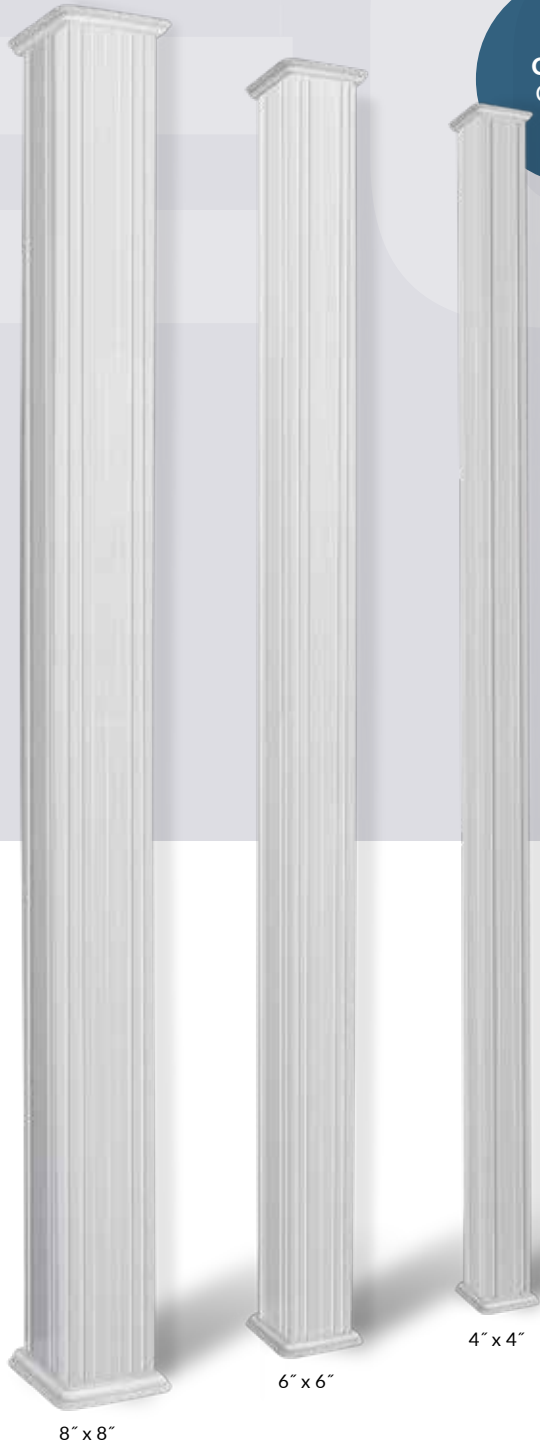

8" x 8"

6" x 6"

4" x 4"

Colonnes  
Columns



6" x 6"

4" x 4"

Poteau  
Post





CARACTÉRISTIQUES

Nos colonnes décoratives de soutien en aluminium ont une finition de peinture cuite et ne nécessitent aucun entretien. Elles ne pourrissent pas, ne s'écaillent pas et ne se détériorent pas. Elles sont idéales pour la construction et la rénovation et peuvent même servir à recouvrir des colonnes existants.

FEATURES

These decorative load bearing aluminium columns have a baked paint finish for years of maintenance-free use. Unlike wood, they will never warp, rot, split, or weather. They can be installed in new constructions or renovations and can even wrap around existing columns.

POTEAU ET COLONNE  
POST AND COLUMN

-  Blanc | White
-  Noyer | Hickory
-  Brun commercial | Commercial Brown
-  Gris charbon\* | Charcoal Grey\*
-  Noir | Black

\*Gris charbon n'est pas disponible pour tous les modèles. | \*Charcoal Grey is not available for all models.  
Consultez les échantillons pour les couleurs exactes et les disponibilités. | Consult our samples for exact colors and availability.



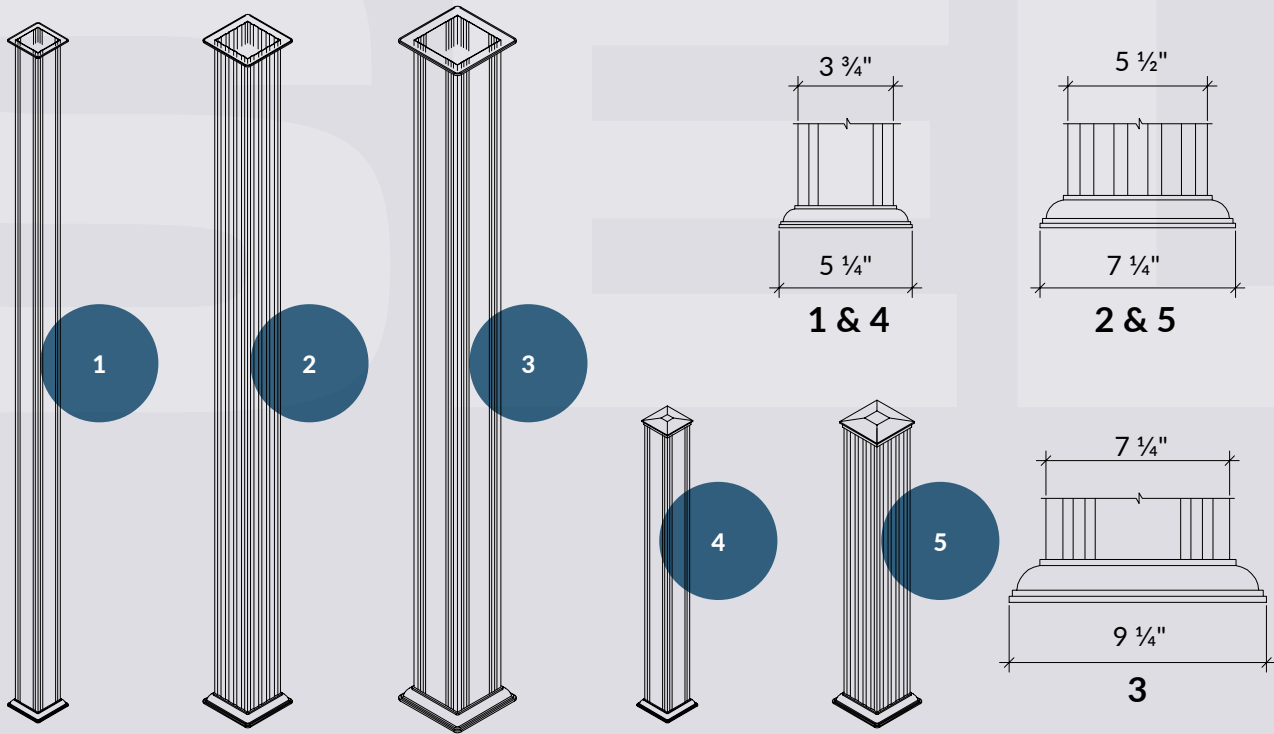

**SPÉCIFICATIONS CARRÉE**  
SPECIFICATIONS SQUARE

Modèle Model	Dimensions Dimensions	Mesures Measures		Charge recommandée Allowable load	
		Hauteur Height	Pièces Pieces	Lbs	Kg
4" x 4"	3 3/4" x 3 3/4" (95 x 95 mm)	8'0" / 2.438 m	2	6600	3000
		9'0" / 2.743 m	2	6400	2909
		10'0" / 3.048 m	2	6200	2818
		12'0" / 3.657 m	2	4740	2155
6" x 6"	5 1/4" x 5 1/4" (133 x 133 mm)	8'0" / 2.438 m	2	12600	5727
		9'0" / 2.743 m	2	10700	4864
		10'0" / 3.048 m	2	9800	4455
		12'0" / 3.657m	2	7400	3364
8" x 8"	7 1/4" x 7 1/4" (184 x 184 mm)	8'0" / 2.438 m	4	12870	5850
		9'0" / 2.743 m	4	10940	4973
		10'0" / 3.048 m	4	10000	4545
		12'0" / 3.657m	4	7950	3614

**POTEAUX**  
POSTS

Modèle Model	Dimensions Dimensions	Poteau / Mesures Post / Measures	
		Hauteur du profilé Height of extrusion	Pièces Pieces
4" x 4"	3 3/4" x 3 3/4" (95 x 95 mm)	38" / 965 mm	2
		44" / 1118 mm	2
		50" / 1270 mm	2
6" x 6"	5 1/4" x 5 1/4" (133 x 133 mm)	38" / 965 mm	2
		44" / 1118 mm	2
		50" / 1270 mm	2





COLONNES RENAISSANCE  
RENAISSANCE COLUMNS



1

2

3

Colonnes  
Columns

Poteau  
Post



Poteau Renaissance | Renaissance Post

- 1. Renaissance
- 2. Combinée Renaissance | S-350  
Renaissance | S-350 Combined
- 3. Combinée double Renaissance | S-350  
Renaissance | S-350 Double combined





CARACTÉRISTIQUES

Ces colonnes en aluminium, de style panneau, ont une indentation. Elles sont porteuses et ont une peinture cuite. La colonne elle-même porte le poids; les bases et chapiteaux sont décoratifs. Les colonnes ne pourrissent pas, ne s'écaillent pas et ne se détériorent pas. Elles ne seront jamais attaquées par les termites. Ces colonnes peuvent même recouvrir des poteaux existants. Elles sont la solution pour ceux qui veulent peu d'entretien.

FEATURES

These panel-style aluminium columns feature a single indent. They are load bearing and have a baked paint finish. The column itself carries the load; the bases and capitals are strictly decorative. Unlike wood, the columns will never rot, split, warp, or weather. They will never be attacked by termites or carpenter ants. These columns can also wrap around existing posts. These are the perfect low-maintenance solution.

POTEAU ET COLONNE  
POST AND COLUMN

-  Blanc | White
-  Noyer | Hickory
-  Brun commercial | Commercial Brown
-  Noir | Black



COLONNES RENAISSANCE  
RENAISSANCE COLUMNS

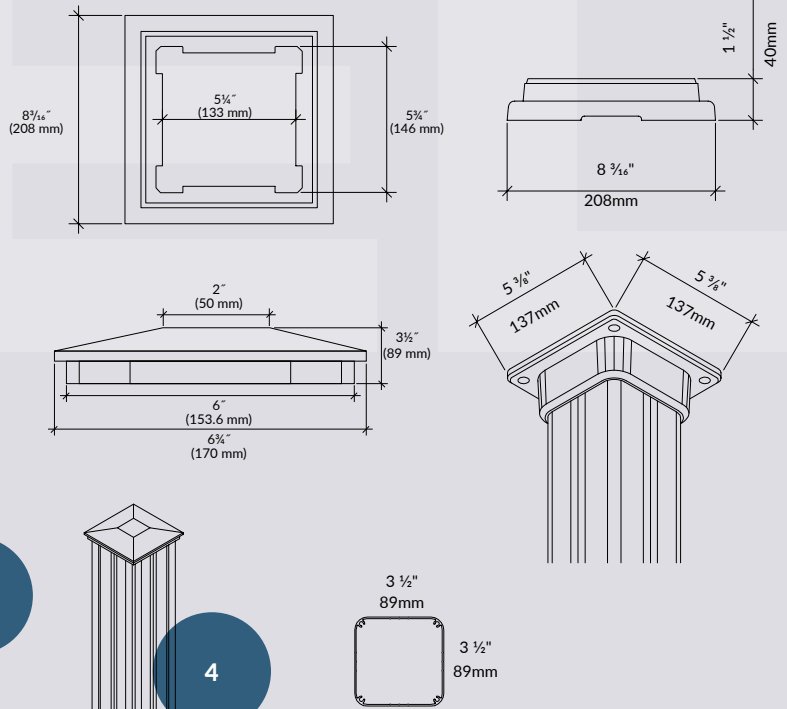
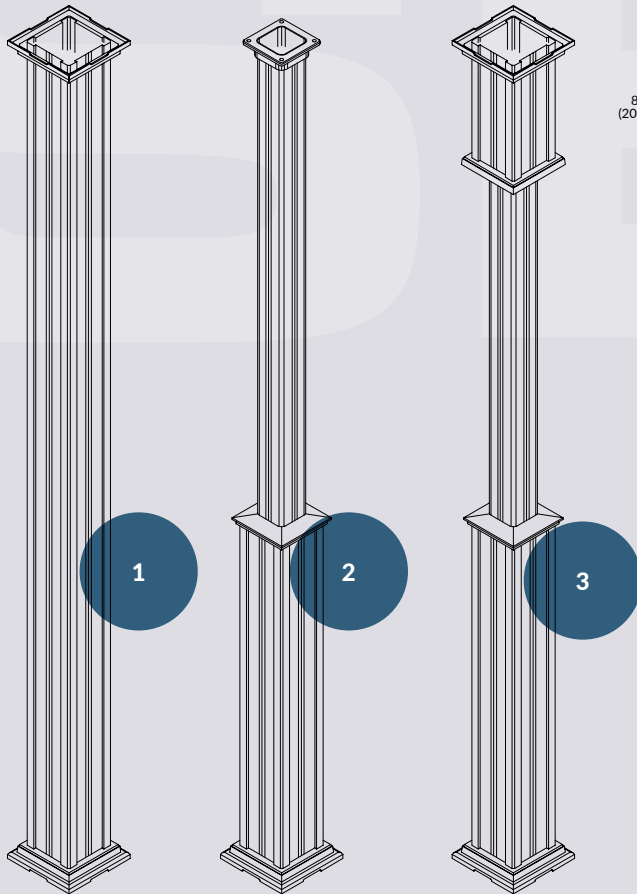

Base et chapiteau  
Base and capital



Capuchon  
Cap



Capuchon Combinée  
Combined Cap



Chapiteau S-350  
S-350 Capital

1 SPÉCIFICATIONS | SPECIFICATIONS

Colonnnes Renaissance seulement | Renaissance Columns only

Dimensions Dimensions	5 3/4" x 5 3/4" (146 mm x 146 mm)			
Hauteur Height	8'0" (2.438 m)	9'0" (2.743 m)	10'0" (3.048 m)	12'0" (3.657 m)
Poids Weight	Lbs: 12100 kg: 5488	Lbs: 10200 kg: 4626	Lbs: 8800 kg: 3991	Lbs: 6700 kg: 3039
Pièces Pieces	4	4	4	4

POTEAU ET COLONNE  
POST AND COLUMN

- Blanc | White
- Noyer | Hickory
- Brun commercial | Commercial Brown
- Noir | Black



Consultez les échantillons pour les couleurs exactes et les disponibilités. | Consult our samples for exact colors and availability.